

# Fixture Protection Systems

Cabinet Protection  
Fixture Protection Systems  
Cart-Guard  
Chrome Barrier System  
Bollards

# FIXTURE PROTECTION SYSTEMS

## PAGE NO#

|           |                            |
|-----------|----------------------------|
| K1 .....  | Cabinet Protection         |
| K2 .....  | Fixture Protection Systems |
| K3 .....  | Fixture Protection Systems |
| K4 .....  | Cart-Guard                 |
| K5 .....  | Cart-Guard                 |
| K6 .....  | Cart-Guard                 |
| K7 .....  | Cart-Stop RE               |
| K8 .....  | Cart-Stop SS               |
| K9 .....  | Cart-Stop BR               |
| K10 ..... | Chrome Barrier System      |
| K11 ..... | Bollards                   |
| K12 ..... |                            |

# CABINET PROTECTION

K1



- Manufacturing and protection system all in one - built in extruded aluminium components actually add strength and beauty as they cut manufacturing costs and improve quality and durability.
- Simplified construction/assembly - requires only a single pass on a standard hand router, allowing for components to be assembled faster, with fewer steps, requiring less shop space and equipment.
- Cut the use of costly skilled labour without sacrificing quality and design flexibility.
- Allow for use of pre-finished melamine board instead of joining with laminates which is time consuming and costly.
- Different angles can be achieved on the same machining set-up using the appropriate angle extrusion.

Extrusion Length - 5000mm (can be cut to your required length).  
Standard Finish - 10um clear anodised. Powder coating to order.

**AP8011** - 90° Outside Corner

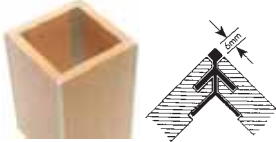

For four-sided fixtures

**AP8012** - 135° Outside Corner



For eight-sided fixtures

**AP8017** - 120° Outside Corner

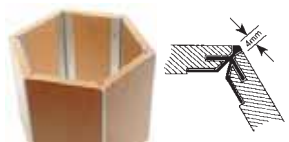

For six-sided fixtures

## SYSTEM TOOLING

To suit large hand held or CNC routers. Requires fence set-up to run the board through 'face up'. A single pass produces the necessary rebate to accept the corner mouldings. Shank - 12mm dia.

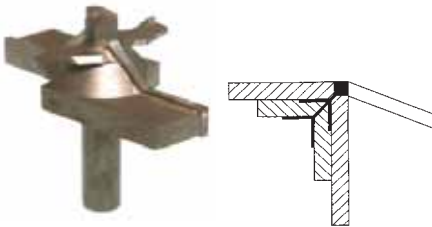

**AP8003**

This system is designed to suit 16 or 18mm board with only a simple height adjustment required to change between the two. However thinner boards can be utilized for lighter weight fixtures by simply glueing a wood strip on the back of the panel prior to shaping.

CALL FOR SAMPLE KIT  
OR SPECIAL DESIGN SOLUTIONS

## LAMINATE PROTECTOR

Small aluminium trim for protecting the top edge of laminate bench tops. Requires special router cutter.



**AP8025** - 2400mm (L).  
Mill finish aluminium.

**AP8026** - Special router cutter  
12.7mm dia. shank.

## PANEL JOINER

Provides neat butt joint for MDF panels of various thicknesses. Machine board with standard slotting cutter.



**AP8020** - 2400mm (L).  
Mill finish aluminium.





# Ouch.

Let's face it – damage happens. Walls and corners look like a war zone, beat up and crumbling before your very eyes. Do you have a strong line of defense to protect your investment from the everyday beating of equipment rolling down your corridors?

Invest in Total Damage Protection today and watch your operating costs and your repair bills go south and your operating profit and customer satisfaction go north.



## RETAIL



Shopping Experience

Operating Costs

Time Savings

## WAREHOUSE/COOLROOM



The ADP range of protection products provides Total Damage Protection for your valuable investment, both in retail and store-room areas. They work on the principle of the time-proven adage that "Prevention is better than cure" by providing impact absorbing solutions that will deflect the barrage of attack from wayward pallet jacks and carefree shopping trolleys. Here are some of the products in this range that can end up saving you thousands of dollars in repair bills over their life-span while enhancing your store image and providing a more rewarding shopping experience for your customers:

- CARTGARD – a range of easily applied plastic sections with excellent shock-displacement dynamics that will stand up handsomely to all kinds of abuse. Available in a range of sizes and colours, they will actually enhance the look of a fixture while ensuring that it will look new for years to come.

- Aluminium corner protection that is actually built in to the cabinet, providing amazing strength to cabinet assembly while preventing corners chipping and creating an aesthetic nightmare.

- CARTSTOP – the universal solution for the protection of walls and columns in the warehouse and stock-room areas. While the base-frame of every pallet jack and stock cart can whack you for literally thousands of dollars of damage overnight, our BoxRail steel rail system with cast aluminium supports can take hits in excess of 1000kg.

# CART-GUARD



## CART-GUARD

- Welcome to the CART-GUARD family of fixture protection products designed to save you dollars and dollars in repair bills caused by wayward shopping trolleys.
- Available in rigid or flexible profiles depending on your fixture design.
- Our new rigid GREEN-GUARD is manufactured from 100% post-industrial material that is 30% stronger than the equivalent PVC product and is 100% recyclable. It is 100% chlorine free and bromine free and does not emit hazardous toxins when incinerated.

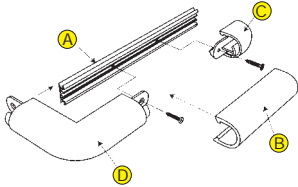

## GREEN-GUARD 1

- Ⓐ Mounting Base - **AP8560** - Length 3660mm
- Ⓑ Rigid Top - **AP8561** - Length 3660mm
- Ⓒ Snap-on end - **AP8565**
- Ⓓ 90° Corner - **AP8566**

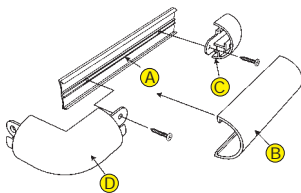
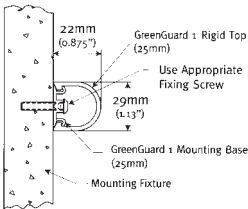

## GREEN-GUARD 2

When the design calls for a 'bold' statement, GREENGUARD 2 offers double the surface area.

- Ⓐ Mounting Base - **AP8570** - Length 3660mm
- Ⓑ Rigid Top - **AP8571** - Length 3660mm
- Ⓒ Snap-on end - **AP8575**
- Ⓓ 90° Corner - **AP8576**

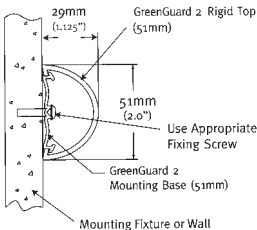

## GREEN-GUARD 3

Wide protection with a series of ribs running down the middle, giving it dimension while performing as an abrasion hider.

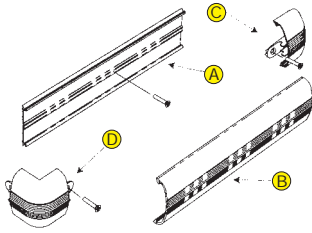

- A** Mounting Base - **AP8580** - Length 3660mm
- B** Rigid Top - **AP8581** - Length 3660mm
- C** Snap-on end - **AP8585**
- D** 90° Corner - **AP8586**

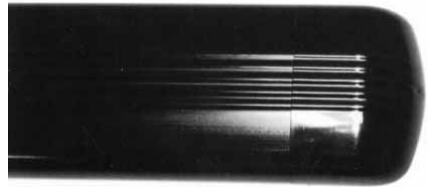
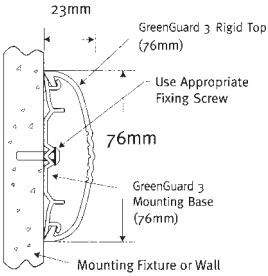

## GREEN-GUARD 8 (RIGID PVC)

Visually striking, low-profile, ribbed design offers a wide band of protection on walls or store fixtures.

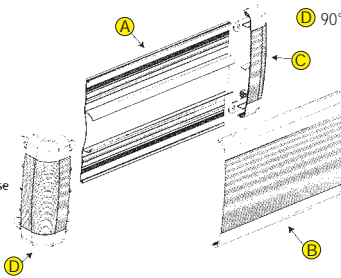
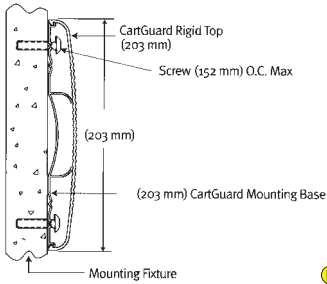

- A** Mounting Base - **AP8555** - Length 3660mm
- B** Rigid Top - **AP8556** - Length 3660mm
- C** Snap-on end - **AP8557**
- D** 90° Corner - **AP8559**



# CART-GUARD

## GENFLEX 1 (FLEXIBLE PVC)

Flexible CARTGUARD offers great design possibilities - can be used to complete a 100mm radius. Use a single row or more if required according to the level of protection you require.

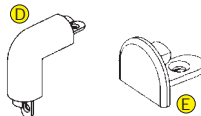
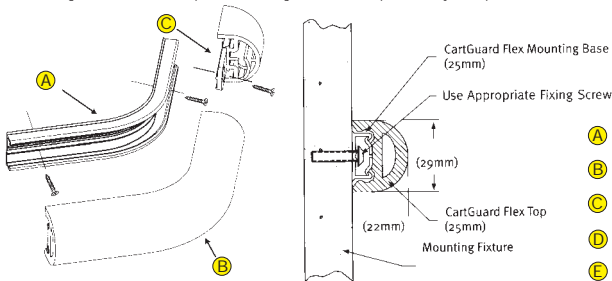

- A** Flexible Mounting Base - **AP8590** - Length 2440mm
- B** Flexible Top - **AP8591** - Length 3660mm
- C** Snap-on end - **AP8593**
- D** 90° Corner - **AP8594**
- E** Flat End Cap - **AP8597**

## GENFLEX 2 (FLEXIBLE PVC)

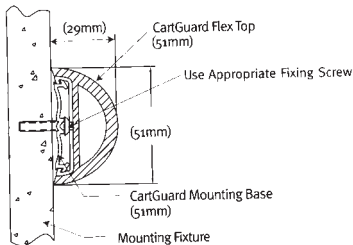
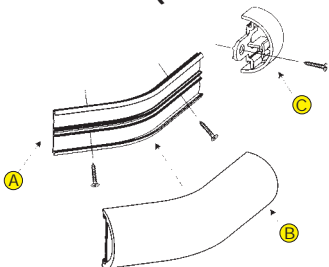

- A** Flexible Mounting Base - **AP8570** - Length 3660mm
- B** Flexible Top - **AP8572** - Length 3660mm
- C** Snap-on end - **AP8575**
- D** 90° Corner - **AP8576**
- E** Flat End Cap - **AP8577**

## CARTGUARD V (RIGID PVC)

Whether you are trying to protect new or existing walls, columns, blockwork corners or just trying to cover up old damage, CARTGUARD V will get the job done quickly while being able to be used in conjunction with the horizontal lines of the other CARTGUARD products.

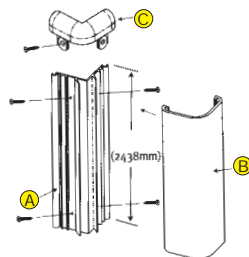
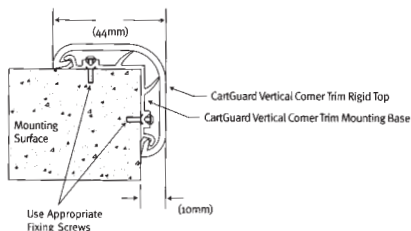

- A** Vertical Corner Mounting Base - **AP8600** - Length 2400mm
- B** Rigid PVC Vertical Top - **AP8601** - Length 2400mm
- C** Vertical Corner End Cap - **AP8602**



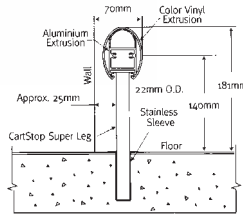
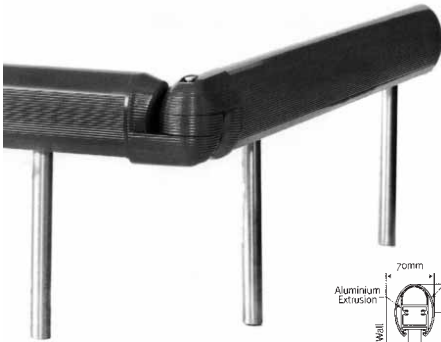

## CART-STOP RE

CART-STOP RE floor mounted bumper is great looking but don't be fooled - its strenght of character derives from its structural integrity that you can't see from the outside\*. CART-STOP RE's unique roller corner re-directs impact energy by spinning away damaging blows from your expensive stor fixtures or glass store fronts\*\*. The roller corner also acts as a hinge that gives you the ability to go around any angle from 90° to 180°.

\*The internal strength of aluminium extrusion with the cladding of PVC that is reversable to give twice the life.

\*\*The complete bumper rail including the legs can be easily removed for floor cleaning.

## ALUMINIUM EXTRUSION

Double hollow aluminium channel.

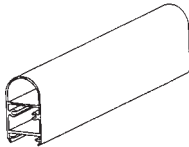

**AP8610** - 3660mm (L)

## RIGID PVC BUMPER COVER

Simply clips over aluminium extrusion. When one side gets badly worn it can be simply reversed for double the life.

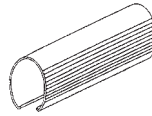

**AP8611** - 3660mm (L)

## PVC ROLLER CORNER

Attaches to aluminium extrusion with self-tapping screws.

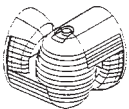

**AP8616**

Choice of colours to match PVC bumper cover.

## END CAPS

Cast aluminium with self-tapping screws.

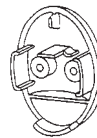

**AP8615**

## STAINLESS STEEL LEG & FLANGE

With set screws. Height - 120mm. Includes flange socket for glueing into floor.

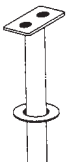

**AP8614**

## WALL-MOUNT BRACKET

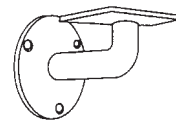

**AP8618**

# CART-STOP SS

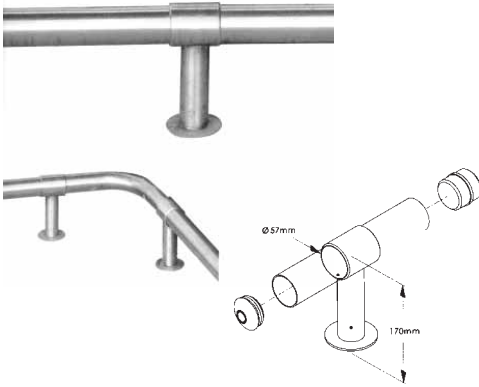

## CART-STOP SS

- CART-STOP SS is a modular fully stainless steel system and is ideal for stopping damage to internal walls and fixtures.
- Perfect for the retailer who wants the clean, simple look of stainless steel without sacrificing strength.
- CART-STOP SS is manufactured from brushed finish #304 grade stainless steel. The non-rusting finish means that it is equally suitable for external use, eg. protecting external glazed walls.

## SLIDE-THROUGH MID LEG

Bolts to floor with expanded bolt. 170mm high overall.

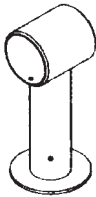

**AP8662**

## TUBE-STAINLESS STEEL

Brushed finish - 57mm dia.

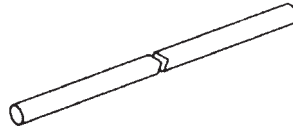

**AP8660** - 2000mm (L)

## 90° BEND

Universal 90° bend for internal or external corners. Brushed finish stainless steel.



**AP8661**

## NYLON END CAP



**AP8666**

## NYLON STRAIGHT JOINER

Use for connecting tubes and bends.



**AP8665**

## DEMOUNTABLE LEG

Includes flange socket for glueing into floors. Allows for removal of rail for easy cleaning.



**AP8663**

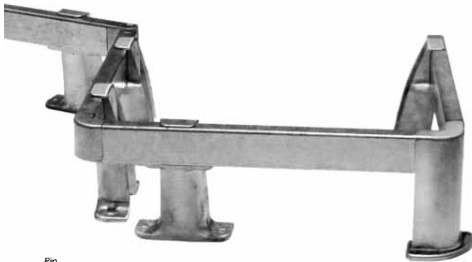

## CART-STOP BR

- CART-STOP BR provides heavy-duty protection in the back room against the daily punishment of warehouse ang stocking equipment.
- Modular design in 2 heights to suit any application.  
High leg - 250mm O/A, Low leg 180mm O/A.
- Galvanised box rail with cast aluminium components.
- Impact resistant to warehouse equipment (tested up to 1100kg).  
Not recommended for fork lift protection.

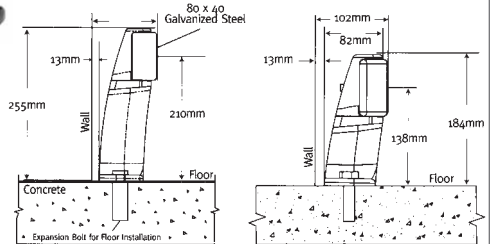
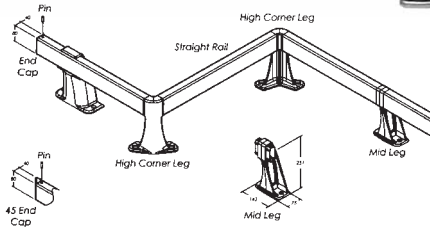

## GALVANISED BOX RAIL & END CAP

80 x 40mm galvanised steel tube.

## PVC COVER

Rigid high-impact PVC in yellow colour provides better visibility.

**AP8637** - Domed End Cap (die-cast aluminium)

**AP8630** - 2000mm (L)

**AP8638** - 2500mm (L)

## LEG BRACKET

Die cast aluminium with tightening screws.

## MID LEG BRACKET

Die cast aluminium. USE FOR JOINING BOX RAILS



**AP8631** - High Leg

**AP8632** - Low Leg

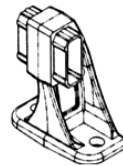

**AP8651** - High Leg

**AP8652** - Low Leg

## CORNER LEG BRACKET

Die cast aluminium with tightening screws.

## ADJUSTABLE CORNER

Die cast aluminium.

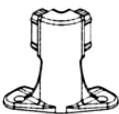

**AP8655** - High Leg

**AP8656** - Low Leg



**AP8658**

# CHROME BARRIER SYSTEM



## CHROME BARRIER SYSTEM

- Our modular Chrome Barrier System is suited to all retail store configurations and requirements.
- Its many uses include creating in-store trolley bays, queuing systems and controlling customer flow.
- Consists of posts in various configurations with various length connecting tubes in a high quality polished chrome finish.

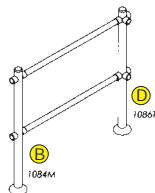
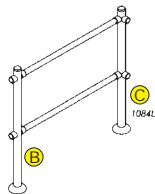
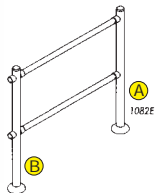

## CHROME UPRIGHTS

High quality polished chrome finish - 1080mm high. 48mm dia.



**A** Upright End  
**AP8680**



**B** Upright Middle  
**AP8682**



**C** Upright Corner  
**AP8684**



**D** Upright 'T'  
**AP8686**

## CHROME CONNECTING TUBES

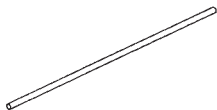

|               | L (mm) | To suit<br>post centres |
|---------------|--------|-------------------------|
| <b>AP8681</b> | 420    | 500                     |
| <b>AP8683</b> | 920    | 1000                    |
| <b>AP8685</b> | 1420   | 1500                    |
| <b>AP8687</b> | 1920   | 2000                    |

## CHROME CONNECTING CUPS



**AP8688** - Post Cup  
Concave to fix to barrier post.



**AP8689** - Post Cup  
Flat to fix to wall.

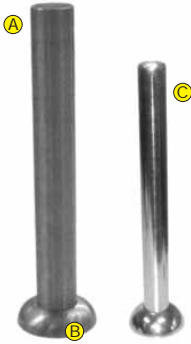

## BOLLARDS

Floor-mounted bollards are designed to protect exposed columns, expensive refrigeration units and all store fixtures, helping them to stay looking great and reduce maintenance costs.

- A AP8645** Stainless Steel Post  
610mm - high bolts directly to floor with expanding bolts.
- B AP8647** Stainless Steel Post Cap  
Slips over the top of the stainless steel post to cover the fixings.
- C AP8649** Chrome Finish Steel Post  
610mm high - includes top cap and base cover.

## ECO BOLLARDS

Our range of external bollards bring safety and organisation to carpark areas, perfectly protecting pedestrians and defining walkways. With the addition of a steel core, they are ideal for protecting ATM machines and store fronts from attacks by ram-raiders.

Now you have the added advantage of being environmentally friendly as the decorative cover is produced from 100% recycled plastic.



### Carpark Specification

1000mm above ground, black colour plastic with 2 reflectors.  
Includes steel core - 90mm dia. x 1500mm high

#### AP8672

### Ram-Raid Specification

1000mm above ground, black colour plastic with 2 reflectors.  
Includes steel core - 90mm dia. x 2000mm high

#### AP8674

### Surface Mounted

1000mm high, black colour plastic with 2 reflectors. Includes steel core - 90mm dia. x 960mm long fixing flange.

#### AP8676



